



BERLI[®]
MACCHINE AGRICOLE

**ZETA
TFB/Y
TFB/C
TFB/REV
TFB/M
TFB/ME**



Trinciatutto da vigneto e frutteto per trattori da 40 a 180 HP



Mulchers for vineyard and orchard for tractors from 40 to 180 HP



Mulchgeräte für Wein- und Obstbau für Traktoren von 40 bis 180 PS



Broyeurs à vignobles et vergers pour tracteurs de 40 a 180 CV



Trituradoras para viñedos y frutales para tractores de 40 a 180 CV



L'esperienza di oltre 60 anni nel settore delle macchine agricole permette alla ditta Berti di offrire alla sua vasta clientela una gamma completa di attrezzature tecnologicamente avanzate al servizio di un'agricoltura sempre più esigente e specializzata. La qualità dei prodotti fin dalla materia prima, la volontà di soddisfare sempre e prima di tutto le esigenze della clientela, la robustezza, l'affidabilità, hanno dato vita al largo consenso che queste macchine hanno ricevuto in tutto il mondo.



The experience of more than 60 years in the manufacturing manufacturing of farm implements makes it possible for Berti Company to offer a complete range of technologically advanced mulchers and shredders, to serve a more and more demanding and specialized agriculture. The high quality, the sturdiness and the reliability of the products, the will to satisfy always the customer's requirement are the reasons of the large success enjoyed by these implements worldwide.





Die Firma Berti hat mehr als 60 Jahre Erfahrung auf dem Gebiet der Landwirtschaftsmaschinen und ist also imstande, ihren zahlreichen Kunden eine komplette Palette von technologisch fortgeschrittenen Landwirtschaftsausrüstungen zu Verfügung zu stellen.

Die Produktqualität, gekennzeichnet durch die Wahl von Rohstoffen erster Klasse, die Beständigkeit und die Zuverlässigkeit der Maschinen, hat die Firma in die Lage gesetzt, diese in der ganzen Welt einzusetzen.

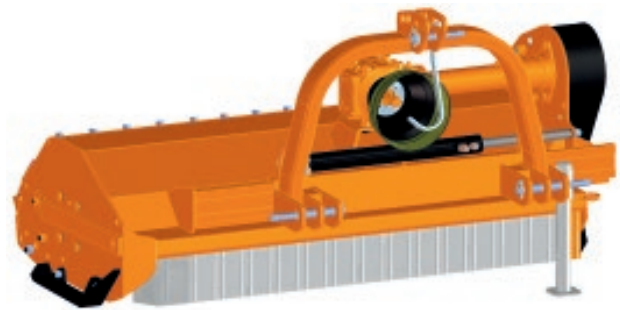

L'expérience acquise au cours de plus de 60 ans de la machine agricole permet à la firme Berti d'offrir à ses nombreux clients une gamme complète d'équipements technologiquement à l'avant-garde au service d'une agriculture exigeante et professionnelle. La qualité des produits à partir de la matière première, la volonté de satisfaire surtout les exigences de la clientèle, la résistance et la fiabilité ont permis à nos machines d'obtenir un accueil très favorable dans le monde entier.



La experiencia de más de 60 años en el sector de las máquinas agrícolas ha permitido a la empresa Berti ofrecer a sus clientes una gama completa de equipos tecnológicamente avanzados para una agricultura cada vez más especializada. Gracias a la robustez y a la fiabilidad de los productos y a una calidad que se busca incluso en las materias primas empleadas, unido a la voluntad de satisfacer siempre y en primer lugar las exigencia de los clientes, Berti se ha hecho famosa en todo el mundo.

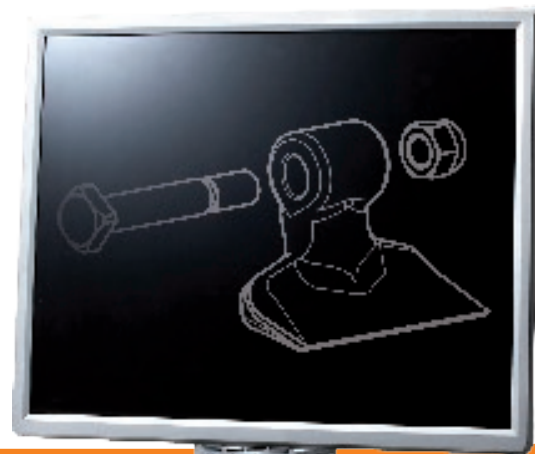

ZETA



Trinciatrice da frutteto e vigneto per erba e sarmenti da applicare a trattori con potenza compresa tra 60 e 100 HP.



Mulcher for vineyard and orchard, suited to mulch grass, bushes, pruning and branches for tractors from 60 to 100 HP.



Mulchgerät für Wein- und Obstbau, für Traktoren von 60 bis 100 PS. Es eignet sich zum Mulchen von Gras, Büsche und Äste.



Broyeur à vignobles et vergers indiqué pour broyer l'herbe, les buissons, les sarments et les tiges pour tracteurs de 60 à 100 CV.



Trituradora para viñedos y frutales apta para triturar hierba, sarmientos y residuos de madera para tractores con una potencia entre 60 y 100 CV.

STRENX®
PERFORMANCE STEEL



- Attacco ai tre punti spostabile meccanicamente su tubi cromati, Cat. II.
- Displaceable 3-points linkage, on chromate tubes, Cat. I-II (mechanical).
- Versetzbarer Dreipunktbock, Kat. I-II (mechanischer).
- Attelage déportable à 3 points, Cat. I-II, avec tuyaux chromés (mécanique).
- Enganche a los tres puntos movable sobre tubos cromados, Cat. I-II (desplazamiento mecánico).



- Tenditori automatici delle cinghie.
- Full automatic belts adjusters.
- Automatische Riemenspannungen.
- Tendeurs automatiques des courroies.
- Tensores automáticos de las correas.

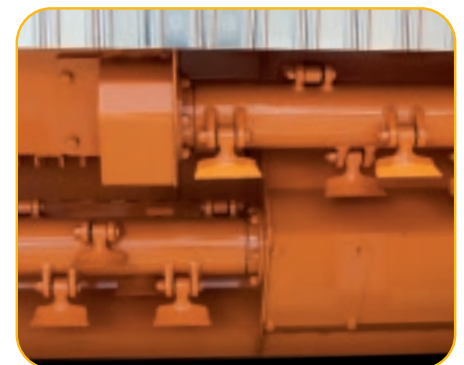

- Doppia trasmissione centrale a cinghie.
- Double and central belts transmission.
- Doppelter und mittiger Keilriemenantrieb.
- Double et central transmission par courroies.
- Doble transmisión central con correas.

Mod.													
	I ↔ I	Min	Max	mm	n°	n°	n°	PTO	A	B	C	min	max
ZETA 150	150	60	100	940 560 560 940	8+8	24+24	3+3	540 (1000)	96	152	160	690	800
ZETA 170	170	60	100	1040 660 660 1040	8+8	24+24	3+3	540 (1000)	96	172	160	740	850
ZETA 190	190	60	100	1140 760 760 1140	10+10	30+30	3+3	540 (1000)	96	192	160	790	900
ZETA 210	210	70	100	1240 860 860 1240	10+10	30+30	3+3	540 (1000)	96	212	160	840	950
ZETA 230	230	70	100	1340 960 960 1340	12+12	36+36	3+3	540 (1000)	96	232	160	890	1000
ZETA 250	250	70	100	1440 1060 1060 1440	12+12	36+36	3+3	540 (1000)	96	252	160	940	1050



- Tirante terzo punto.
- Top link tie-rod.
- Oberlenk Zugstange.
- Tige de renfort au troisième point.
- Tirante de refuerzo.



- Rullo livellatore regolabile con pulirullo.
- Adjustable and levelling roller, with scraper.
- Einstellbare Stützwalze mit Abstreifer.
- Rouleau palpeur réglable avec décrotoir.
- Rodillo nivelador con rascador.



- Fiancate laterali prive di sporgenze.
- Chamfered and smooth sides of chassis
- Seitenbleche, ohne Vorsprungen.
- Côtés latéraux sans saillies
- Costados laterales sin salientes.

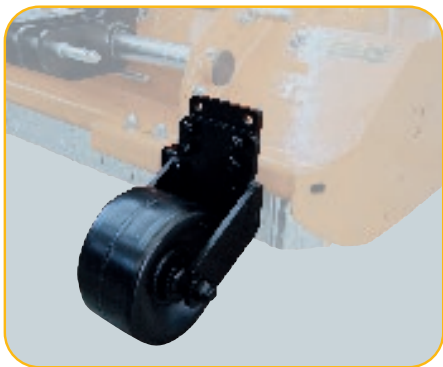

- Ruote fisse anteriori stabilizzatrici, regolabili in altezza.
- Height adjustable front and fixed wheels.
- Regulierbare und feste Stützräder für Frontanbau.
- Roues frontales fixes et réglables en hauteur.
- Ruedas frontales estabilizadoras fijas y regulables en altura.

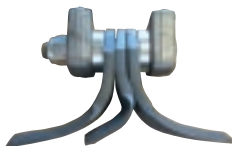
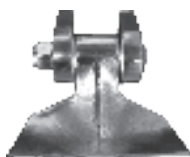

Optional

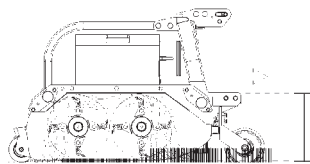

H = 42 cm

OPTIONALS



- Spostamento idraulico con tubi e innesti rapidi.
- Hydraulic side shift with hoses and quick couplings.
- Hydraulische Seitenverschiebung.
- Déport hydraulique avec tuyaux et prises rapides.
- Desplazamiento hidráulico.



- Ruote in gomma fisse anteriori.
- Fixed rubber wheels, front mounted.
- Feste Gummistützräder vorne.
- Roues frontales fixes en caoutchouc.
- Ruedas delanteras fijas de goma.



- Ruote in gomma pivotanti anteriori (per uso frontale)
- Pivoting rubber wheels, front mounted (for front use)
- 360° schwenkbare Gummistützräder vorne (für Frontanbau)
- Roues pivotantes frontales en caoutchouc (pour utilisation frontal)
- Ruedas pivotantes y delanteras en goma (Para uso frontal)



- Rastrelli raccoglitori (solo per uso posteriore).
- Collecting rakes (only for rear use).
- Sammelrechen (nur für Heckverwendung).
- Râteaux ramasseurs (ne que pour use arrière).
- Rastrillos recogedores (solo por uso posterior).

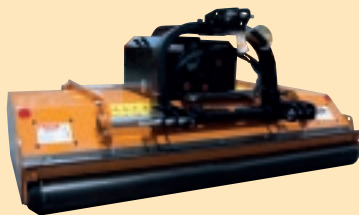

- Versione frontale.
- Front version.
- Front Version.
- Version avant.
- Versión delantera.



- Albero cardanico con ruota libera.
- PTO drive shaft with free wheel.
- Gelenkwelle mit Freilauf.
- Arbre cardan avec roue libre.
- Cardan con rueda libre.

TFB/Y



STRENX®
PERFORMANCE STEEL



Trinciatrice da frutteto e vigneto per erba, sarmenti e materiale legnoso fino a Ø 8 cm., da applicare a trattori con potenza compresa tra 60 e 110 HP.



Mulcher for vineyard and orchard, suited to mulch grass, bushes, pruning and branches up to Ø 8 cm. for tractors from 60 to 110 HP.



Mulchgerät für Wein- und Obstbau, für Traktoren von 60 bis 110 PS. Es eignet sich zum Mulchen von Gras, Büsche und Äste bis Ø 8 cm.



Broyeur à vignobles et vergers indiqué pour broyer l'herbe, les buissons, les sarments et les tiges allant jusqu'à Ø 8 cm, pour tracteurs de 60 à 110 CV.



Trituradora para viñedos y frutales apta para triturar hierba, sarmientos y residuos de madera en general de hasta 8 cm. de diámetro para tractores con una potencia entre 60 y 110 CV.











- Attacco ai 3 punti spostabile meccanicamente, Cat. I-II.
- Displaceable 3 point linkage, Cat. I-II (mechanical).
- Versetzbarer Dreipunktbock, Kat. I-II (mechanischer).
- Attelage déportable à 3 points, Cat. I-II (mécanique).
- Enganche a los 3 puntos Cat. I-II (desplazamiento mecánico).



- Tenditore automatico delle cinghie.
- Full automatic belts adjuster.
- Automatische Riemenspannung.
- Tendeur automatique des courroies.
- Tensor automático de las correas.

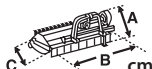

- Fiancata destra arrotondata.
- Chamfered profile on the right-end chassis' corner.
- Seitlich Abschrägung auf Mulcherrahmen.
- Coin côté droite arrondi.
- Perfil rebajado en la parte derecha.

Mod.													
		cm	Min					Max	mm	n°	n°	n°	PTO
TFB/Y 120	120	60	110	685 515 315 885	12	36	4	540 (1000)	100	140	120	560	720
TFB/Y 140	140	60	110	875 525 355 1045	12	36	4	540 (1000)	100	160	120	610	770
TFB/Y 160	160	60	110	875 725 355 1245	14	42	4	540 (1000)	100	180	120	660	840
TFB/Y 180	180	60	110	875 925 355 1445	16	48	4	540 (1000)	100	200	120	700	890
TFB/Y 200	200	80	110	875 1125 355 1645	18	54	4	540 (1000)	100	220	120	740	940
TFB/Y 220	220	80	110	1040 1160 520 1680	20	60	4	540 (1000)	100	240	120	790	990
TFB/Y 250	250	80	110	1040 1460 520 1980	22	66	5	540 (1000)	100	270	120	890	1100

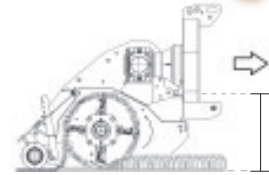

H = 47 cm (120-220)
H = 49 cm (250)

- Rullo livellatore regolabile con pulirullo e rastrelli raccoglitori.
- Adjustable and levelling roller, with scraper and rakes.
- Einstellbare Stützwalze mit Abstreifer und Sammelrechen.
- Rouleau palpeur réglable avec décrottoir et râteaux ramasseurs.
- Rodillo nivelador con rascador y rastrillos recogedores.

Optional

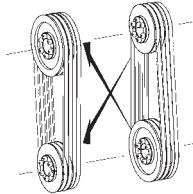

- PTO 540/1000 g/min (invertendo le pulegge).
- PTO 540/1000 rpm (reversing the pulleys).
- Getriebe 540 oder 1000 U/min (Umkehrbare Riemenscheibe).
- PDF 540/1000 t/min (en inversant les poulies).
- PTO 540/1000 g/min (invirtiendo las poleas).

OPTIONALS



- Spostamento idraulico con tubi e innesti rapidi.
- Hydraulic side shift with hoses and quick couplings.
- Hydraulische Seitenverschiebung.
- Déport hydraulique avec tuyaux et prises rapides.
- Desplazamiento hidráulico.



- Rullo posteriore livellatore con diametro maggiorato.
- Rear leveling roller with big diameter.
- Heck- Stuetzwalze mit grossem Durchmesser.
- Rouleau niveleur arrière avec majeur diamètre.
- Rodillo nivelador trasero de mayor diámetro.



- Attacco centrale.
- Centre mounted linkage.
- Mittiger Anbau.
- Attelage axial.
- Enganche central.



- Kit ruote sterzanti.
- Steering wheels.
- Satz Hinterlenkräder.
- Jeu roues directrices.
- Ruedas directrices.



- Slitte di appoggio.
- Skids.
- Satz Kufen.
- Jeu patins.
- Patines.

Mod.	mm	
	1046	554
TFB/Y 160	524	1076
TFB/Y 180	1046	754
TFB/Y 200	524	1276
	1216	784
TFB/Y 220	694	1306
	1326	874
TFB/Y 250	804	1396
	1560	940
	1040	1460



- Ruote frontali stabilizzatrici, regolabili in altezza.
- Front wheels kit.
- Regulierbare Stützräder für Frontanbau.
- Jeu roues frontales.
- Ruedas frontales estabilizadoras y regulables en altura.



- Albero cardanico.
- Pto drive shaft.
- Gelenkwelle.
- Arbre cardan.
- Cardan.

TFB/C



Trinciatrice da frutteto e vigneto per erba, sarmenti e materiale legnoso fino a Ø 8 cm., da applicare a trattori con potenza compresa tra 60 e 110 HP.



Mulcher for vineyard and orchard, suited to mulch grass, bushes, pruning and branches up to Ø 8 cm. for tractors from 60 to 110 HP.



Mulchgerät für Wein- und Obstbau, für Traktoren von 60 bis 110 PS. Es eignet sich zum Mulchen von Gras, Büsche und Äste bis Ø 8 cm.



Broyeur à vignobles et vergers indiqué pour broyer l'herbe, les buissons, les sarments et les tiges allant jusqu'à Ø 8 cm, pour tracteurs de 60 à 110 CV.



Trituradora para viñedos y frutales apta para triturar hierba, sarmientos y residuos de madera en general de hasta 8 cm. de diámetro para tractores con una potencia entre 60 y 110 CV.

STRENX®
PERFORMANCE STEEL













- Attacco ai 3 punti spostabile meccanicamente, Cat. I-II e tirante terzo punto.
- Displaceable 3 points linkage, Cat. I-II (mechanical) and top link tie-rod.
- Versetzbarer Dreipunktbock, Kat. I-II (mechanischer) und Oberlenk Zugstange.
- Attelage déportable à 3 points, Cat. I-II (mécanique) et tige de renfort au troisième point.
- Enganche a los 3 puntos desplazable Cat. I-II (desplazamiento mecánico) y tirante de refuerzo.



- Tenditore automatico delle cinghie.
- Full automatic belts adjuster.
- Automatische Riemenspannung.
- Tendeur automatique des courroies.
- Tensor automático de las correas.



- Fiancata destra arrotondata.
- Chamfered profile on the right-end chassis' corner.
- Seitlich Abschrägung auf Mulcherrahmen.
- Coin côté droite arrondi.
- Perfil rebajado en la parte derecha.

Mod.													
	cm	Min	Max	mm	n°	n°	n°	PTO	A	B	C	min	max
TFB/C 140	140	60	110	875 525	12	36	4	540 (1000)	100	160	130	650	810
				355 1045									
TFB/C 160	160	60	110	875 725	14	42	4	540 (1000)	100	180	130	700	880
				355 1245									
TFB/C 180	180	60	110	875 925	16	48	4	540 (1000)	100	200	130	740	930
				355 1455									
TFB/C 200	200	80	110	875 1125	18	54	4	540 (1000)	100	220	130	780	980
				355 1645									
TFB/C 220	220	80	110	1040 1160	20	60	4	540 (1000)	100	240	130	830	1030
				520 1680									
TFB/C 250	250	80	110	1040 1460	22	66	5	540 (1000)	100	270	130	930	1150
				520 1980									

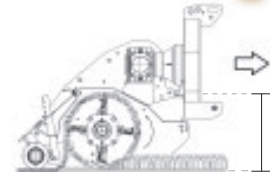

H = 47 cm (140-220)
H = 49 cm (250)

- Rullo livellatore regolabile con pulirullo e rastrelli raccoglitori.
- Adjustable and levelling roller, with scraper and rakes.
- Einstellbare Stützwalze mit Abstreifer und Sammelrechen.
- Rouleau palpeur réglable avec décrottoir et râteaux ramasseurs.
- Rodillo nivelador con rascador y rastrillos recogedores.

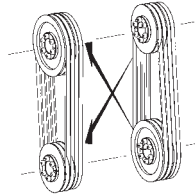

- PTO 540/1000 g/min (invertendo le pulegge).
- PTO 540/1000 rpm (reversing the pulleys).
- Getriebe 540 oder 1000 U/min (Umkehrbare Riemenscheibe).
- PDF 540/1000 t/min (en inversant les poulies).
- PTO 540/1000 g/min (invirtiendo las poleas).

OPTIONALS



- Spostamento idraulico con tubi e innesti rapidi.
- Hydraulic side shift with hoses and quick couplings.
- Hydraulische Seitenverschiebung.
- Déport hydraulique avec tuyaux et prises rapides.
- Desplazamiento hidráulico.



- Rullo posteriore livellatore con diametro maggiorato.
- Rear leveling roller with big diameter.
- Heck- Stuetzwalze mit grossem Durchmesser.
- Rouleau niveleur arrière avec majeur diamètre.
- Rodillo nivelador trasero de mayor diámetro.



- Attacco centrale.
- Centre mounted linkage.
- Mittiger Anbau.
- Attelage axial.
- Enganche central.



- Ruote frontali stabilizzatrici, regolabili in altezza.
- Front wheels kit.
- Regulierbare Stützräder für Frontanbau.
- Jeu roues frontales.
- Ruedas frontales estabilizadoras y regulables en altura.



- Slitte di appoggio.
- Skids.
- Satz Kufen.
- Jeu patins.
- Patines.

Mod.	mm	
	TFB/C 160	1046 554
TFB/C 180	1046 754	524 1276
TFB/C 200	1216 784	694 1306
TFB/C 220	1326 874	804 1396
TFB/C 250	1560 940	1040 1460



- Kit ruote sterzanti.
- Steering wheels.
- Satz Hinterlenkräder.
- Jeu roues directrices.
- Ruedas directrices.



- Albero cardanico.
- Pto drive shaft.
- Gelenkwelle.
- Arbre cardan.
- Cardan.

TFB/REV

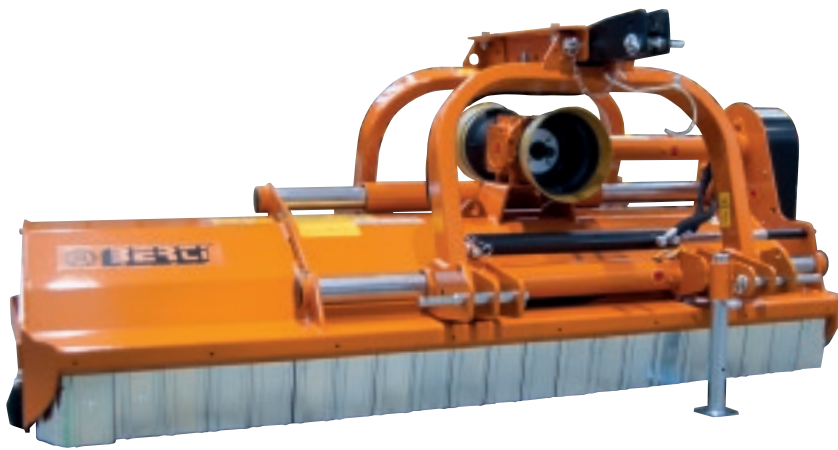

STRENX®
PERFORMANCE STEEL



Trinciatrice compatta applicabile su sollevatore anteriore o posteriore del trattore (anche a guida retroversa), con potenze comprese tra 60 e 110 HP. Consigliata per vigneti e frutteti per la trinciatura di erba, sarmenti, ramaglia fino a Ø 8 cm.



Front and rear compact mulcher to fit tractors from 60 to 110 HP. Suited to mulch grass, bushes, pruning and branches up to Ø 8 cm., on vineyards and orchards.



Heck- und Frontanbau Mulchgerät für den Wein- und Obstbau, für Traktoren von 60 bis 110 PS. Es eignet sich zum Mulchen von Gras, Büsche und Äste bis Ø 8 cm.



Broyeur réversible pour tracteurs de 60 à 110 CV. Indiqué pour broyer l'herbe, les buissons, les sarments et les tiges allant jusqu'à Ø 8 cm. dans les vignobles ou les vergers.



Trituradora para tractores reversibles con una potencia entre 60 y 110 CV. Apta para viñedos y frutales, para triturar hierba, sarmientos y ramaje en general de hasta 8 cm. de diámetro.













- Doppio attacco ai 3 punti spostabile meccanicamente e reversibile, Cat. I-II.
- Displaceable and reversible double 3 points linkage Cat. I-II (mechanical).
- Doppelter versetzbarer und umkehrbarer Dreipunktbock, Kat. I-II (mechanischer).
- Double attelage déportable et réversible à 3 points, Cat. I-II (mécanique).
- Doble enganche a los 3 puntos desplazable y reversible Cat. I-II (desplazamiento mecánico).



- Tenditore automatico delle cinghie.
- Full automatic belts adjuster.
- Automatische Riemenspannung.
- Tendeur automatique des courroies.
- Tensor automático de las correas.



- Fiancata destra arrotondata.
- Chamfered profile on the right-end chassis' corner.
- Seitlich Abschrägung auf Mulcherrahmen.
- Coin côté droite arrondi.
- Perfil rebajado en la parte derecha.

Mod.										
	cm	Min Max	mm	n°	n°	n°	PTO	A B C	min	max
TFB/REV 140	140	60 110	875 525 355 1045	12	36	4	540 (1000)	110 160 125	710	830
TFB/REV 160	160	60 110	875 725 355 1245	14	42	4	540 (1000)	110 180 125	750	890
TFB/REV 180	180	60 110	875 925 355 1455	16	48	4	540 (1000)	110 200 125	800	950
TFB/REV 200	200	80 110	875 1125 355 1645	18	54	4	540 (1000)	110 220 125	840	1000
TFB/REV 220	220	80 110	1040 1160 520 1680	20	60	4	540 (1000)	110 240 125	890	1050



- Slitte di appoggio.
- Skids.
- Satz Kufen.
- Jeu patins.
- Patines.



- Rullo livellatore regolabile con pulirullo e rastrelli raccoglitori.
- Adjustable and levelling roller, with scraper and rakes.
- Einstellbare Stützwalze mit Abstreifer und Sammelrechen.
- Rouleau palpeur réglable avec décrotoir et râteaux ramasseurs.
- Rodillo nivelador con rascador y rastrillos recogedores.

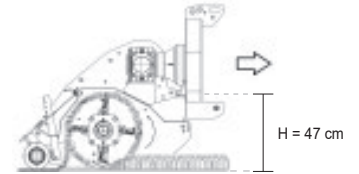

- Doppia ruota libera nella scatola ingranaggi*.
- Double free wheel in the gearbox*.
- Doppelten Freilauf im Getriebe*.
- Double roue libre dans le boîtier*.
- Doble rueda libre en la caja de transmisión*.

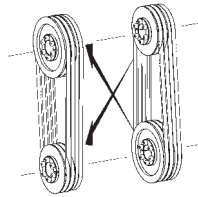
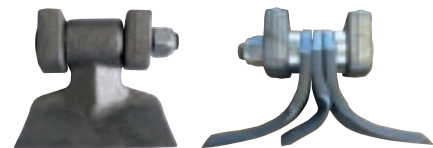

- PTO 540/1000 g/min (invertendo le pulegge).
- PTO 540/1000 rpm (reversing the pulleys).
- Getriebe 540 oder 1000 U/min (Umkehrbare Riemenscheibe).
- PDF 540/1000 t/min (en inversant les poulies).
- PTO 540/1000 g/min (invirtiendo las poleas).

OPTIONALS



- Spostamento idraulico con tubi e innesti rapidi.
- Hydraulic side shift with hoses and quick couplings.
- Hydraulische Seitenverschiebung.
- Déport hydraulique avec tuyaux et prises rapides.
- Desplazamiento hidráulico.



- Rullo posteriore livellatore con diametro maggiorato.
- Rear leveling roller with big diameter.
- Heck- Stuetzwalze mit grossem Durchmesser.
- Rouleau niveleur arrière avec majeur diamètre.
- Rodillo nivelador trasero de mayor diámetro.

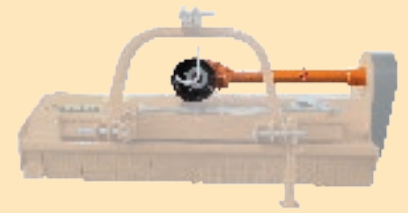

- Attacco centrale.
- Centre mounted linkage.
- Mittiger Anbau.
- Attelage axial.
- Enganche central.



- Albero cardanico.
- Pto drive shaft.
- Gelenkwelle.
- Arbre cardan.
- Cardan.

Mod.	mm	
TFB/REV 160	1025	575
	505	1095
TFB/REV 180	1025	775
	505	1295
TFB/REV 200	1195	805
	675	1325
TFB/REV 220	1305	895
	785	1415

TFB/M



STRENX®
PERFORMANCE STEEL

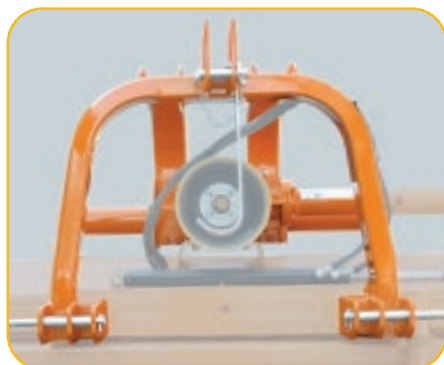

- Attacco ai 3 punti spostabile meccanicamente, Cat. II e tirante terzo punto.
- Displaceable three points linkage, Cat. II (mechanical) and top link tie-rod.
- Versetzbarer Dreipunktbock, Kat. II (mechanischer) und Oberlenk Zugstange.
- Attelage déportable à 3 points, Cat. II (mécanique) et tige de renfort au troisième point.
- Enganche a los 3 puntos desplazable Cat. II (desplazamiento mecánico) y tirante de refuerzo.



- Tenditore automatico delle cinghie.
- Full automatic belts adjuster.
- Automatische Riemenspannung.
- Tendeur automatique des courroies.
- Tensor automático de las correas.



Trinciatrice rinforzata per vigneto, frutteto e sottobosco consigliata per erba cespugli sarmenti e materiale legnoso fino a Ø 10-12 cm., da applicare a trattori con potenze comprese tra 70 e 150 HP.



Heavy duty mulcher for orchard and under-wood, suited to mulch grass, bushes, pruning and branches up to Ø 10-12 cm. for tractors from 70 to 150 HP.











Verstärkte Mulchgerät für den Wein- und Obstbau, für Traktoren von 70 bis 150 PS. Es eignet sich zum Mulchen von Gebüsch und Sträuchern und Äste bis Ø 10-12 cm.



Broyeur renforcé pour vergers et sous-bois indiqué pour broyer l'herbe, les buissons, les sarments et les tiges allant jusqu'à Ø 10-12 cm., pour tracteurs de 70 à 150 CV.



Trituradora reforzada para la trituración desde hierba hasta restos leñosos (hasta 10-12 cm. Ø) en viñedos, y otras explotaciones agrícolas. Para tractores desde 70 hasta 150 CV.

Mod.	 cm	 HP		 mm	 n°	 n°	 PTO	 cm			 min	 max
		Min	Max					A	B	C		
TFB/M 180	180	70	110	956 844 434 1366 1046 954	16	5	540 (1000)	115	200	140	875	995
TFB/M 200	200	70	110	524 1476 1046 954	18	5	540 (1000)	115	220	140	925	1050
TFB/M 200 Special	200	80	150	524 1476 1046 1154	18	5	540 (1000)	120	220	140	990	1125
TFB/M 220	220	80	150	524 1676 1046 1454	20	5	540 (1000)	120	240	140	1050	1195
TFB/M 250	250	100	150	524 1976 1046 1754	22	5	1000 (540)	120	270	140	1125	1280
TFB/M 280	280	100	150	524 2276 1046 1954	26	5	1000 (540)	120	300	140	1195	1365
TFB/M 300	300	100	150	524 2476	28	5	1000 (540)	120	320	140	1235	1415

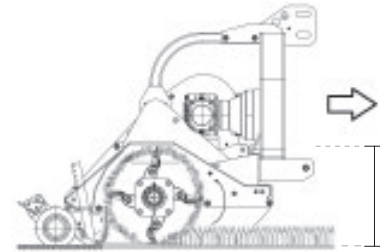

H = 50 cm (180-200)
H = 54 cm (200S-300)

- Rullo livellatore regolabile con pulirullo e rastrelli raccoglitori.
- Adjustable and levelling roller, with scraper and rakes.
- Einstellbare Stützwalze mit Abstreifer und Sammelrechen.
- Rouleau palpeur réglable avec décrotoir et râteaux ramasseurs.
- Rodillo nivelador con rascador y rastrillos recogedores.

OPTIONALS

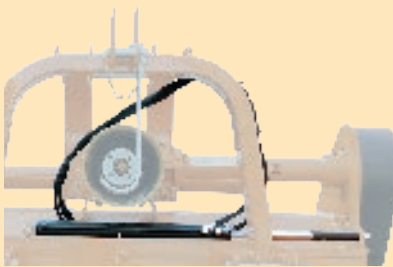

- Spostamento idraulico con tubi e innesti rapidi.
- Hydraulic side shift with hoses and quick couplings.
- Hydraulische Seitenverschiebung.
- Déport hydraulique avec tuyaux et prises rapides.
- Desplazamiento hidráulico.



- Slitte di appoggio.
- Skids.
- Satz Kufen.
- Jeu patins.
- Patines.



- Attacco centrale.
- Centre mounted linkage.
- Mittiger Anbau.
- Attelage axial.
- Enganche central.



- Ruote anteriori stabilizzatrici, regolabili in altezza.
- Height adjustable front wheels.
- Regulierbare Stützräder für Frontanbau.
- Roues frontales réglables en hauteur.
- Ruedas frontales estabilizadoras y regulables en altura.



- Albero cardanico.
- Pto drive shaft.
- Gelenkwelle.
- Arbre cardan.
- Cardan.

Mod.	mm	
	1616	1184
TFB/M 280	1094	1706
TFB/M 300	1616	1384
	1094	1906

TFB/ME



STRENX®
PERFORMANCE STEEL



Trinciatrice rinforzata per vigneto, frutteto e sottobosco consigliata per erba cespugli sarmenti e materiale legnoso fino a Ø 12 cm., da applicare a trattori con potenze comprese tra 80 e 180 HP.



Heavy duty mulcher for orchard and under-wood, suited to mulch grass, bushes, pruning and branches up to Ø 12 cm. for tractors from 80 to 180 HP.



Verstärkte Mulchgerät für den Wein- und Obstbau, für Traktoren von 80 bis 180 PS. Es eignet sich zum Mulchen von Gebüsch und Sträuchern und Äste bis Ø 12 cm.



Broyeur renforcé pour vergers et sous-bois indiqué pour broyer l'herbe, les buissons, les sarments et les tiges allant jusqu'à Ø 12 cm., pour tracteurs de 80 à 180 CV.



Trituradora reforzada para la trituración desde hierba hasta restos leñosos (hasta 12 cm. Ø) en viñedos, y otras explotaciones agrícolas. Para tractores desde 80 hasta 180 CV.



- Attacco ai 3 punti con doppia posizione di aggancio spostabile idraulicamente, Cat. II.
- Displaceable three-point hitch Cat. II, with two coupling positions (hydraulic).
- Versetzbarer Dreipunktbock Kat. II, mit zwei Kupplungspositionen möglich (hydraulischer).
- Attelage déportable à 3 points Cat. II, avec deux positions possibles (hydraulique).
- Enganche a los 3 puntos desplazable Cat. II (desplazamiento hidráulico) con dos posiciones de acoplamiento posibles.



- Tenditore automatico delle cinghie.
- Full automatic belts adjuster.
- Automatische Riemenspannung.
- Tendeur automatique des courroies.
- Tensor automático de las correas.



- Rullo livellatore regolabile con pulirullo.
- Adjustable and levelling roller with scraper.
- Einstellbare Stützwalze mit Abstreifer.
- Rouleau palpeur réglable avec décrotoir.
- Rodillo nivelador con rascador.

Mod.													
	cm	Min	Max	mm	mm	n°	n°	PTO	A	B	C	min	max
TFB/ME 200	200	80	180	700 0 1300 2300	1000 0 1000 2000	18	5	540 (1000)	115	230	147	1110	1190
TFB/ME 220	220	80	180	700 0 1500 2500	1000 0 1200 2200	20	5	540 (1000)	115	250	147	1190	1280
TFB/ME 250	250	80	180	700 0 1800 2800	1000 0 1500 2500	22	5	540 (1000)	115	280	147	1280	1370



- Protezioni frontali in catena e gomma.
- Front chains protectors and rubber.
- Frontschutze mit Ketten und Gummi.
- Protections frontales par chaînes et caoutchouc.
- Protecciones frontales en cadenas con goma.



- Albero cardanico rinforzato.
- Hardened PTO drive shaft.
- Verstärkte Gelenkwelle.
- Arbre cardan à profil renforcé.
- Cardan reforzado.

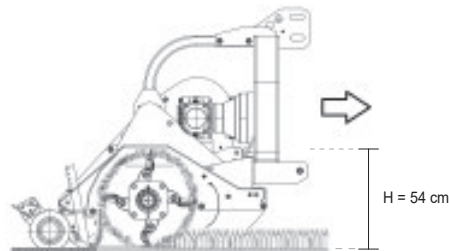
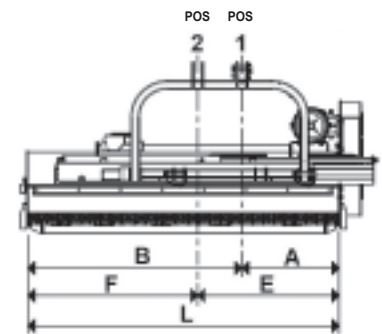
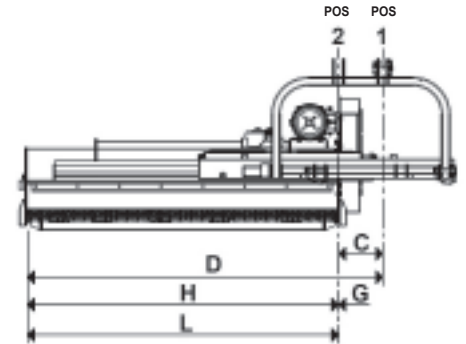

Mod.	POS. 1 (mm)					POS. 2 (mm)			
	L	A	B	C	D	E	F	G	H
TFB/ME 200	200	700	1300	300	2300	1000	1000	0	2000
TFB/ME 220	220	700	1500	300	2500	1000	1200	0	2200
TFB/ME 250	250	700	1800	300	2800	1000	1500	0	2500

OPTIONALS



- Slitte di appoggio.
- Skids.
- Satz Kufen.
- Jeu patins.
- Patines.



- Rastrelli raccoglitori.
- Rakes.
- Sammelrechen.
- Râteaux ramasseurs.
- Rastrillos recogedores.



- Kit segnaletica stradale con luci.
- Set road-warning panels with lights.
- Satz Warntafel mit Beleuchtung.
- Kit de signalisation avec système d'éclairage.
- Kit de señalización de carretera con luces.



bertima.it



ZETA



TFB/Y



TFB/C

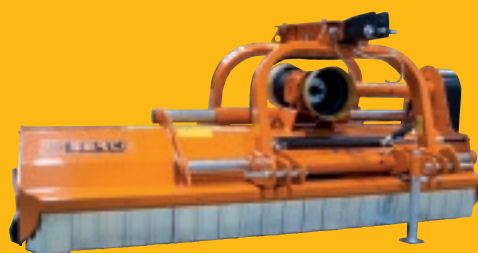

TFB/REV

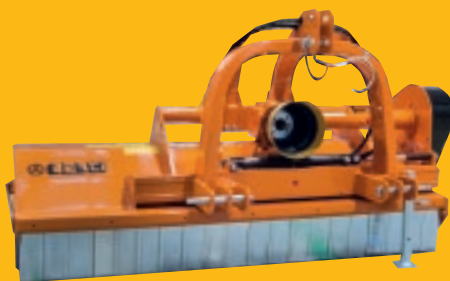

TFB/M



TFB/ME

Le illustrazioni e i dati del presente catalogo sono indicative e non vincolanti per il costruttore • All pictures and data above are indicative only and not binding for the manufacturer • Alle in diesem Katalog enthaltenen Angaben und Zeichnungen sind annahmend und unverbindlich • Toutes les données insérées dans ce catalogue ont été indiquées seulement à titre de renseignement • Las fotografías y los datos mostrados son meramente indicativos y podrían ser variados sin previo aviso por el fabricante.



BERTI[®]
MACCHINE AGRICOLE



Via Musi, 1/A-3-4 - 37042 Caldiero (VR) ITALY
Tel. +39.045.6139711 - Fax +39.045.6150251
info@bertima.it



 **MADE IN ITALY**

D011.14 REV.03 - 06.06.2021